

DTR.LI-24(ENG)

APLISENS

**MANUFACTURE OF PRESSURE TRANSMITTERS
AND CONTROL INSTRUMENTS**





USER'S MANUAL

**RAIL-MOUNTED
SMART TEMPERATURE TRANSMITTER
TYPE LI-24**

Edition G

WARSAW MAY 2017

Symbols used

Symbol	Description
	Warning to proceed strictly in accordance with the information contained in the documentation in order to ensure the safety and full functionality of the device.
	Information particularly useful during installation and operation of the device.
	Information particularly useful during installation and operation of a type Ex device.
	Information on disposal of used equipment

BASIC REQUIREMENTS AND SAFE USE

 - **The manufacturer will not be liable for damage resulting from incorrect installation, failure to maintain the device in a suitable technical condition, or use of the device other than for its intended purpose.**

- Installation should be carried out by qualified staff having the required authorizations to install electrical devices. The installer is responsible for performing the installation in accordance with these instructions and with the electromagnetic compatibility and safety regulations and standards applicable to the type of installation.
- The device should be configured appropriately for the purpose for which it is to be used. Incorrect configuration may cause erroneous functioning, leading to damage to the device or an accident.
- If a device is not functioning correctly, disconnect it and send it for repair to the manufacturer or to a firm authorized by the manufacturer.

 In order to minimize the risk of malfunction and associated risks to staff, the device is not to be installed or used in particularly unfavourable conditions, where the following dangers occur:

- possibility of mechanical impacts, excessive shocks and vibration;
- excessive temperature fluctuation,
- condensation of water vapour, large dust, icing.

 Installation of intrinsic safety versions should be performed with particular care, in accordance with the regulations and standards applicable to that type of installation.

The manufacturer reserves the right to make changes (not having a negative impact on the operational and metrological parameters of the products) without updating the contents of the technical manual.

CONTENTS

1. INTRODUCTION	2
2. APPLICATIONS AND MAIN FEATURES	2
3. CONSIGNMENT CONTENTS	2
4. CONSTRUCTION AND MEASUREMENT PRINCIPLES	2
4.1. Electronic System – block diagram.....	3
5. USE OF THE LI-24 TRANSMITTERS IN DANGER ZONES	3
5.1. List of norms.....	3
5.2. LI-24 transmitters identification symbols.....	3
5.3. Permitted intrinsic-safety parameters	4
5.3.1. Permitted sensors supply parameters (to 1, 2, 3, 4, 5 terminal sensors connection)	4
5.3.2. Permitted input parameters (to <DC>, <DC> terminals current loop)	4
5.4. Supply examples	4
5.4.1. - Power supply with linear characteristics	4
5.4.2. – Power supply with the trapezoidal characteristics	4
5.4.3. - Power supply with the rectangular characteristics	5
5.5. Assembly recommendations	5
5.5.1. General recommendations	5
5.5.2. Special conditions for safe use according to FTZU 08 and ATEX 0160X Certificates.	5
5.5.3. LI-24 connecting at danger area.	6
6. TECHNICAL PARAMETERS.	6
6.1. Electrical parameters:.....	6
6.2. Metrological parameters:.....	7
6.2.1. Input data, accuracy.	7
6.3. Input with 2 sensors:.....	8
6.4. Normal usage conditions:.....	9
7. SENSORS CONNECTION OPTIONS TO LI-24 TRANSMITTER.	10
8. LI-24 TRANSMITTER CONFIGURATION	11
9. SAFETY CONDITIONS.	11
10. STORAGE AND TRANSPORT.	11
10.1. Storage.....	11
10.2. Transport	11
11. WARRANTY.	11
12. FIGURES	12
Fig.1. LI-24 transmitter – block diagram.	3
Fig.2. The supplying principle with a source of linear characteristics.....	4
Fig.3. The supplying principle with a source of trapezoidal characteristics.	4
Fig.4 The supplying principle with a source of rectangular characteristics.....	5
Fig.5. Connecting transmitter circuit – sensors connecting according to p.7.....	6
Fig.6. Supply voltage in load resistance (Ro) function for LI-24 transmitter. Safe working area (grid) upper colour area.....	6
Fig.7. Sensors connection options to LI-24 transmitter.	10
Fig.8. Circuit LI-24 transmitter to configuration with PC computer and Hart-RS converter	11
Fig.9. Smart temperature transmitter type LI-24, dimensions, description.....	12

SMART TEMPERATURE TRANSMITTERS TYPE LI-24
NORMAL VERSIONS
Ex VERSIONS

1. INTRODUCTION

This Manual is intended for users of smart temperature transmitters type **LI-24** – in normal and intrinsic-safety versions.

The data and information for the intrinsically safe **LI-24** transmitter are given at point 5 „**Use of the LI-24 transmitter in danger zones**“.

The data and parameters specified in other points of the Manual are common for both versions, and several differences relate to electrical supply have been taken into the text.

2. APPLICATIONS AND MAIN FEATURES



The rail-mounted smart temperature transmitters **LI-24** are designed to resistance and voltage conversion in 4 – 20mA measuring signal with Hart communication. Transmitters have two measuring canals which carry through measuring difference, middle, middle with redundancy, minimum and maximum of temperature. Transmitters are factory compensated from ambient temperature effect and have compensation possibility of thermocouple cold lead ends with inside or offside sensors.

The **LI-24** transmitter features:

- a) Two-wire power supply (4...20mA current loop),
- b) Digital signal processing (filtration, linearization, compensation),
- c) Transmitter configuration possibility (with Hart Protocol) as sensor type, calibration, programming and range difference, user measuring profile enabling.
- d) Autodiagnostic system
- e) Ability to cooperate with resistive and thermocouple sensors, (see table 1 and 2)
- f) Ambient temperature effect compensation
- g) Input/output galvanic separation.

3. CONSIGNMENT CONTENTS

Together with the transmitter are delivered :

- a) Product certificate, which is also as the warranty card,
- b) LI-24 Ex Declaration of Conformity, or LI-24 Declaration of Conformity - on request,
- c) LI-24 Ex Certificate copy– on request,
- d) User's Manual signed „DTR.LI-24(ENG)“.

Items b), c), d) are available at www.aplisens.pl

4. CONSTRUCTION AND MEASUREMENT PRINCIPLES

All electronic components of the LI-24 temperature transmitter are mounted on the single printed-circuit board.

Transmitter housing type:	- rail-mounted, plastic PA
Transmitter dimensions:	- according to Fig.9
Index of the case protection:	- IP20
Diameter cable to the transmitter connecting:	- ≤ 2,5 mm ²

4.1. Electronic System – block diagram.

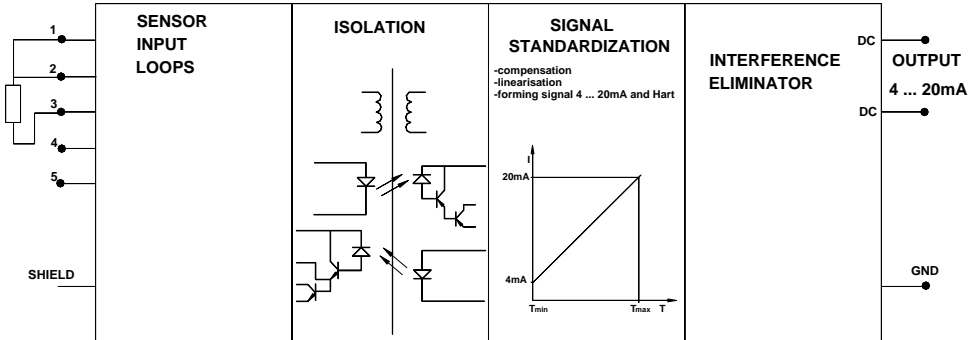

Fig.1. LI-24 transmitter – block diagram.

5. USE OF THE LI-24 TRANSMITTERS IN DANGER ZONES

5.1. List of norms.

The transmitters are made in according to the requirements of the following standards:

EN 60079-0:2012+A11:2013, EN 60079-11:2012, EN 50303:2000.

The transmitters can be operated in explosion danger areas in accordance with the explosion-proof construction symbol:



II 1G Ex ia IIC T4/T5 Ga
I M1 Ex ia I Ma
FTZU 08 ATEX 0160X

5.2. LI-24 transmitters identification symbols.

Intrinsically safe transmitters must have a rating plate with the following data:

- The name of the producer;
 - The LI-24 transmitter type;
 - CE symbol and the Notified Body number;  symbol;
 - Explosion-proof construction index, certificate symbol as p.5.1;
 - Input parameters values: U_i , I_i , P_i , C_i , L_i and U_o , I_o , P_o , C_o , L_o ;
 - Measurement range and output signal;
 - Manufacture year and serial number;
- and additionally:
- front rating plate with sign leads;
 - warning plate with inscription: „Don't dry wipe“;
 - leads signs.

5.3. Permitted intrinsic-safety parameters

5.3.1. Permitted sensors supply parameters (to 1, 2, 3, 4, 5 terminal sensors connection)

$$U_o = 6V, I_o = 0.1A, C_o = 10\mu F, L_o = 1.5mH, P_o = 0.5W$$

5.3.2. Permitted input parameters (to <DC>, <DC> terminals current loop)

The transmitters should be powered from power suppliers with the relevant intrinsic safety certificates, with output parameters to danger zone not exceed the acceptable supply parameters to the transmitters as below:

- a) Power supply with linear characteristics
 $U_i = 30V, I_i = 0.1A, P_i = 0.75W, L_i = 1.1mH, C_i = 5nF$ $T_a \leq 70^\circ C$ and T5
- b) Power supply with the trapezoidal characteristics
 $U_i = 24V, P_i = 0.7W, I_i = 0.05A, L_i = 1.1mH, C_i = 5nF$ $T_a \leq 75^\circ C$ and T5
- c) Power supply with the rectangular characteristics
 $U_i = 24V, P_i = 0.6W, I_i = 0.025A, L_i = 1.1mH, C_i = 5nF$ $T_a \leq 75^\circ C$ and T5
 $U_i = 24V, P_i = 1.2W, I_i = 0.05A, L_i = 1.1mH, C_i = 5nF$ $T_a \leq 75^\circ C$ and T4

5.4. Supply examples



Used below signs U_o and I_o accord to transmitter supply and are other than above mentioned (p. 5.3.1)

5.4.1. - Power supply with linear characteristics

Power supply with a "linear" characteristic may be a typical barrier with parameters:

$$U_o = 30V \quad I_o = 0.1A \quad R_w = 300\Omega$$

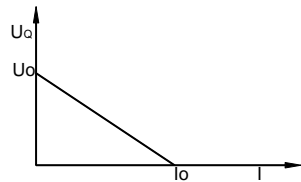
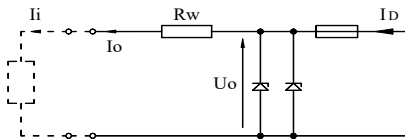

Fig.2. The supplying principle with a source of linear characteristics

5.4.2. - Power supply with the trapezoidal characteristics

$$U_o = 24V \quad I_o = 0.05A \quad P_o = 0.6W \quad U_Q = 48V$$

for $T_a \leq 75^\circ C$ and T5

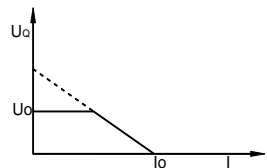
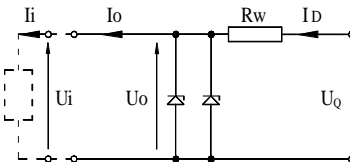

Fig.3. The supplying principle with a source of trapezoidal characteristics.

If $U_o < \frac{U_Q}{2}$ parameters U_o, I_i, P_i are interrelated as follows:

$$U_o = \frac{4P_o}{I_o}$$

$$R_w = \frac{4P_o}{I_o^2}$$

$$P_o = \frac{U_o \cdot (U_Q - U_o)}{R}$$

5.4.3. - Power supply with the rectangular characteristics

$$U_i = 24V \quad I_i = 0,05A \quad P_i = 1,20W$$

$$T_a \leq 75^\circ\text{C} \text{ and } T_4$$

Power supply with the rectangular characteristics means that the intrinsically safe supplier voltage does not change until the current limiter is activated.

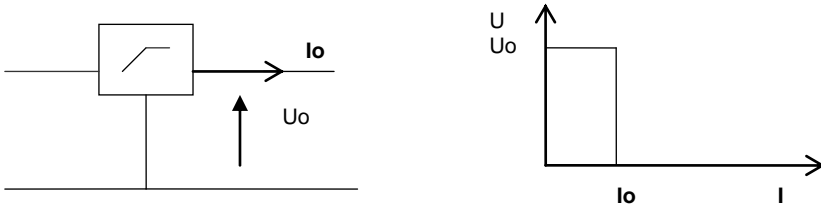

Fig. 4 The supplying principle with a source of rectangular characteristics.

The power supplier with rectangular characteristics usually has the "ib" protection level. Each transmitter powered from such supplier is also the intrinsically safe device with "ib" protection level.

5.5. Assembly recommendations

5.5.1. General recommendations

The LI-24 Transmitter connection should be made in accordance with fig. 5. The transmitter should be assembled at horizontal rail in the connecting boxes. Should be kept min distance 50mm between the terminals and the conducted circuit accessories galvanic separated. If the distances aren't kept is necessary to apply the isolated or grounded conducted partition. The next electrical installations in the box should be assembled in the way encroaching of separation rules between intrinsically safe circuits and non intrinsically safe circuits. At the boxes and at the cases should be put the signs informing about assembled devices and about leading out places. Essential for the proper transmitter working with the outside part measuring system is connecting of transmitter with regard to the intrinsically rules (EN 600079-25) as well as the maintenance of entrance / exit parameters.



It is not allowed to repair or otherwise interfere with the transmitter's electrical circuits in any way. Assessment of damage and any necessary repairs may be carried out only by the manufacturer or by a firm authorized by the manufacturer.

5.5.2. Special conditions for safe use according to FTZU 08 and ATEX 0160X Certificates.



When installed as category G equipment, the unit must be mounted inside of enclosure or under the cover complying with requirements of EN 600079-0:2009, clause 7.4.2 or 8.1.2 when these are made of plastic and light alloy respectively.



When installed as category M1 or M2 equipment the unit must be mounted inside of enclosure which affords it a degree of protection of at least IP 54. Non metallic enclosures must comply with requirements of EN 60079-0:2009, clause 7.4.2. Light alloy enclosures are not allowed.

5.5.3. LI-24 connecting at danger area.

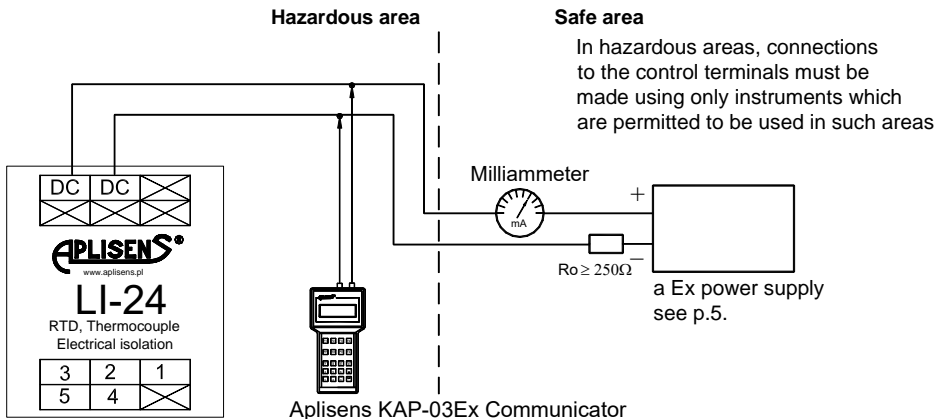

Sensors connection as p.7

Communicator has to have certificate for connection to a signal line leading at the danger zone.
Example Aplsens KAP-03Ex.
If such is missing, the transmitter should be configured and calibrated at a safe zone and communicator can't be connected to line entered to danger zone.

If the resistance seen from the transmitter to the line is $R_o > 250\Omega$ is possible communication with the transmitter via a communicator connection to "DC" and "DC" terminals as shown on figure. (R_o = line resistance + load).
If $R_o < 250\Omega$, there will be no communication and resistance in the measuring line should be increased to at least 250Ω , as shown on figure.

Fig.5. Connecting transmitter circuit – sensors connecting according to p.7.

6. TECHNICAL PARAMETERS.

6.1. Electrical parameters:

- Input signal thermocouple, resistance sensor, resistance, voltage, with accordance to tables 1 and 2
- Output signal 4...20mA + Bell202/Hart Rev.5.1
- Power supply 14 – 50VDC



- Power supply for intrinsic-safe versions - in accordance with p.5.

- Load resistance $R_o = \frac{U_{sup}[V]-14V}{0,023A}$

- Resistance for communication (Hart) 250+1100Ω

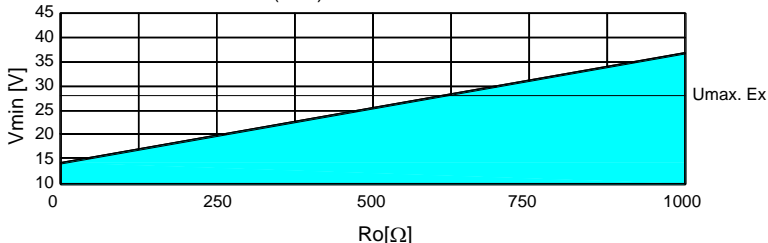

Fig.6. Supply voltage in load resistance (R_o) function for LI-24 transmitter. Safe working area (grid) upper colour area.

List of current alarms

Alarm Type	Value of Alarm Current
NORMAL LOW	3,75 mA
NORMAL HIGH	21,6 mA
NAMUR LOW	3,6 mA
NAMUR HIGH	21,0 mA

Alarm Type	Value of Alarm Current
CUSTOM (value of alarm current is defined by user)	Value of alarm current in interval 3,6 mA ÷ 23 mA
LAST VALUE (transmitter does not update analog exit)	Alarm current value is equal to the current value in the time preceding the event which giving an alarm.

Galvanic separation user processing profile

- electrical strength:
- resistance:

1500V rms in 1 min
500MΩ

6.2. Metrological parameters:

- sensors kinds , ranges and accuracy
- user processing profile
- resolution A/C conversion
- input impedance, thermocouples or voltage inputs
- supply voltage changes error
- temperature error
- temperature compensation
- output signal setting time
- additional voltage damping
- time of single conversion

see table 1.
to 50 measuring points
24 bit
>10MΩ
± 0,002%/V
see table 1
50 points at temperature working range segmental with linear approximation between points
0.3 – 1.2s
0 – 30s
200 ÷ 1000ms

6.2.1. Input data, accuracy.

Table 1. Sensor types, ranges, accuracy.

Sensor RTD 2,3,4-wires connection						
Input – RTD						
Thermoresistance sensors					2,3,4-wires connection	
Sensor current					~420uA	
Max. wires resistance					25Ω	
Sensor type	Standard	Normal range	Min. measuring range	Accuracy Δp	Temperature error Δtp	Analogue output error
1	2	3	4	5	6	7
Pt10 (α=0.003850)	IEC751, DIN43760, JISC 1604-97, BS 1904	-200÷850	10	±0.8	±0.035	Analogue output error: 0,05% FSO(Full Scale Output) in all temperature working range
Pt50 (α=0.003850)		-200÷850	10	±0.2	±0.0070	
Pt100 (α=0.003850)		-200÷850	10	±0.07	±0.0035	
Pt200 (α=0.003850)		-200÷850	10	±0.2	±0.0020	
Pt500 (α=0.003850)		-200÷850	10	±0.05	±0.0007	
Pt1000 (α=0.003850)		-200÷266	10	±0.03	±0.0003	
Pt 98 (α=0.003923)	SAMA RC-4-1966	-200÷650	10	±0.07	±0.0035	
Ni100 (W100=1.617)	PN-83/M- 53952	-60 ÷ 180	10	±0.07	±0.0030	
Cu100 (W100=1.426)		-50 ÷ 180	10	±0.07	±0.0030	
Pt10 (α=0.003916)	JIS C1604- 81	-200÷630	10	±0.8	±0.035	
Pt50 (α=0.003916)		-200÷630	10	±0.2	±0.0070	
Pt100 (α=0.003916)		-200÷630	10	±0.07	±0.0035	

Pt10 (W100=1.3910)	GOST 6651-94	-200+1100	10	±0.8	±0.035	Analog output error: 0,05% FSO(Full Scale Output) in all temperature working range
Pt50 (W100=1.3910)		-200+1100	10	±0.2	±0.0070	
Pt100 (W100=1.3910)		-200+1100	10	±0.07	±0.0035	
Pt500 (W100=1.3910)		-200+1100	10	±0.05	±0.00070	
Cu50 (W100=1.426)		-50 ÷ 200	10	±0.2	±0.0070	
Cu100 (W100=1.426)		-50 ÷ 200	10	±0.07	±0.0030	
Cu50 (W100=1.428)		-185 ÷ 200	10	±0.2	±0.0070	
Cu100 (W100=1.428)		-185 ÷ 200	10	±0.07	±0.0030	
Ni100 (W100=1.617)		-60 ÷ 180	10	±0.07	±0.0030	
Resistance (resistor, potentiometer)						
		Ω	Ω	mΩ	mΩ	As above
Zakres pomiarowy 1		0...400	10	±30	±2	
Zakres pomiarowy 2		0...2000	10	±120	±2	
1	2	3	4	5	6	7

6.3. Input with 2 sensors:

- Difference outputs value: Ch1 – Ch2 or Ch2 – Ch1
- Middle outputs value; 0.5 · (Ch1 + Ch2)
- Middle with redundancy outputs value: 0.5 · (Ch1 + Ch2) or Ch2 or Ch1 when this second is damaged

- Minimum outputs value: min (Ch1, Ch2)
- Maximum outputs value: max (Ch1, Ch2)

Table 2. Sensor types, ranges, accuracy.

Thermocouples						
Input – Thermocouple						
Input impedance		>10MΩ				
Max. wires resistance		500Ω (wires + thermocouple)				
Cold ends compensation		internal sensor, external sensor Pt100, state worth				
Sensor type	Standard	Normal range	Min. measuring range	Accuracy Δp	Temperature error Δtp	Analogue output error
		°C	K	K	K/K	%
1	2	3	4	5	6	7
B (Pt30Rh-Pt6Rh)	IEC584, NIST MN175, DIN43710, BS4937, ANSI MC96.1, JIS C1602, NF C42-321	250 ÷ 1820	10	±0.55	<±0.001	Analog output error: 0,05% FSO(Full Scale Output) in all temperature working range
E (Ni10Cr-Cu45Ni)		-200 ÷ 1000	10	±0.15	<±0.001	
J (Fe-Cu45Ni)		-210 ÷ 1200	10	±0.20	<±0.001	
K (Ni10Cr-Ni5)		-200 ÷ 1372	10	±0.30	<±0.001	
N(Ni14CrSi-NiSi)		-200 ÷ 1300	10	±0.25	<±0.001	
R(Pt13Rh-Pt)		-20 ÷ 1768.1	10	±0.35	<±0.001	
S(Pt10Rh-Pt)		-30 ÷ 1768.1	10	±0.40	<±0.001	
T(Cu-Cu45Ni)		-200 ÷ 400	10	±0.15	<±0.001	
TC Typ L,	GOST P 8.585-2001	-200 ÷ 800	10	±0.20	<±0.001	
Internal sensor CJC		-25 ÷ 75		±[0.35+0.007 (T-273)]	<±0.009	

Voltage						
		mV	mV	µV		
Measuring range 1		-10 ... 100	10	±6	<±0.001	As above
Measuring range 2		-100 ... 1000	10	±50	<±0.001	
1	2	3	4	5	6	7

ΔG – limiting error [K] or [%] calculated according to data (Tables 1 and 2).

$$\boxed{i} \quad \Delta G [K] = \Delta p [K] + \Delta tp \frac{[K]}{[K]} \cdot TO [K] + TN [K] \cdot \frac{0.05 [\%]}{100 [\%]} \quad ;$$

$$\Delta G [\%] = \frac{\Delta p [K] \cdot 100\%}{TN [K]} + \frac{\Delta tp [K] \cdot TO [K] \cdot 100\%}{TN [K] [K]} + 0.05\% \quad ;$$

TN [K] - the setting range width of the measured temperature; algebraical difference between upper and bottom limit of setting range.

TO [K] - ambient temperature range width of the transducer; the algebraical difference between upper and bottom ambient temperature (accepted as extreme temperatures of work).

6.4. Normal usage conditions:

- Ambient temperature -25 ... 75°C
- Relative humidity to 80%
- Constant and variable magnetic field 0 ... 400A/m
- Atmosphere components no aggressive components

7. SENSORS CONNECTION OPTIONS TO LI-24 TRANSMITTER.

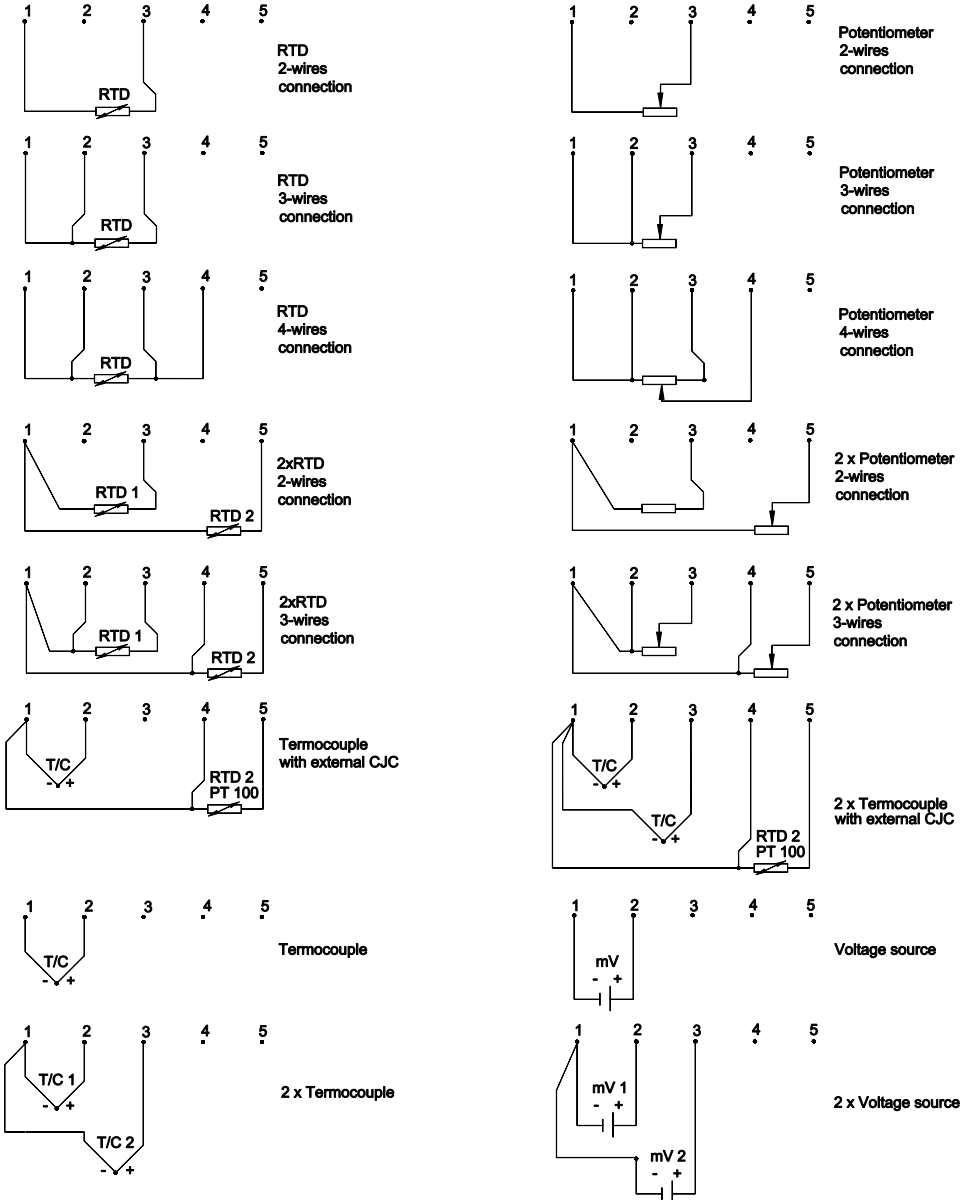

Fig.7. Sensors connection options to LI-24 transmitter.

8. LI-24 TRANSMITTER CONFIGURATION

To transmitter configuration is necessary:

- DC Voltage supplier for example: 24VDC
- KAP 03 or KAP 03Ex communicator
- or
- Hart-RS converter and PC computer with Windows XP / Vista / 7 system and a "Raport 2" or "LI-24 Configurator" configuration program.

Connection as Fig.8

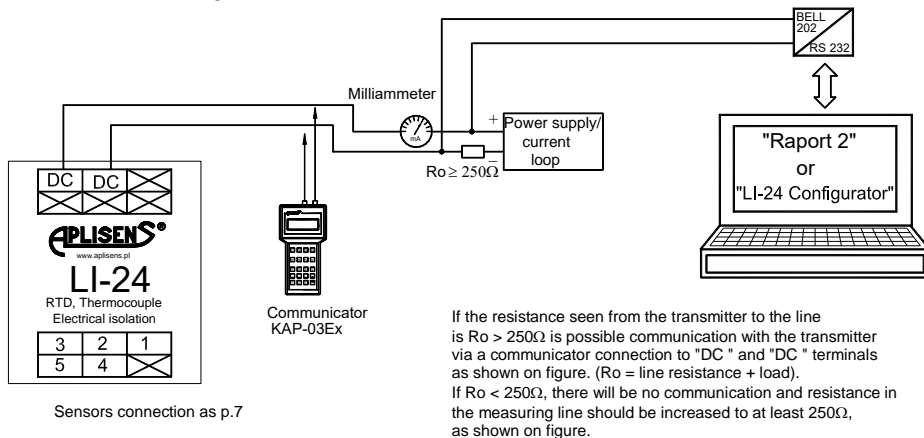

Fig.8. Circuit LI-24 transmitter to configuration with PC computer and Hart-RS converter



After configuration it is important to protect the transducers using command HART [247]. During work transmitter should be safe prior to entries. This prevents accidental or intentional changes configurational data. The protection function is accessible in KAP03 communicator, "Raport 2" or "LI-24 Configurator" software, as well as, in applying DD or DMT programs libraries.

9. SAFETY CONDITIONS.

- All the operations (inspection, verification) can be performed only if the contents of the Manual have been carefully read and understood.
- Before making any connections it is absolutely necessary to disconnect the power supply and input signal.

10. STORAGE AND TRANSPORT.

10.1. Storage.

The transmitter should be stored in original packaging in a closed place, free from any aggressive or corrosion-causing agents, in the temperature from 0°C to 70°C and relative humidity below 80%, protected against vibrations and shock.

10.2. Transport.

The transmitters should be transported in individual packaging and/or bulk packaging by covered means of transportation. The packaging should be secured to stop them from moving and protected from direct impact of weather conditions.

11. WARRANTY.

The producer gives a warranty on terms and conditions determined in the "Product certificate", which is also as the warranty card.

12. FIGURES

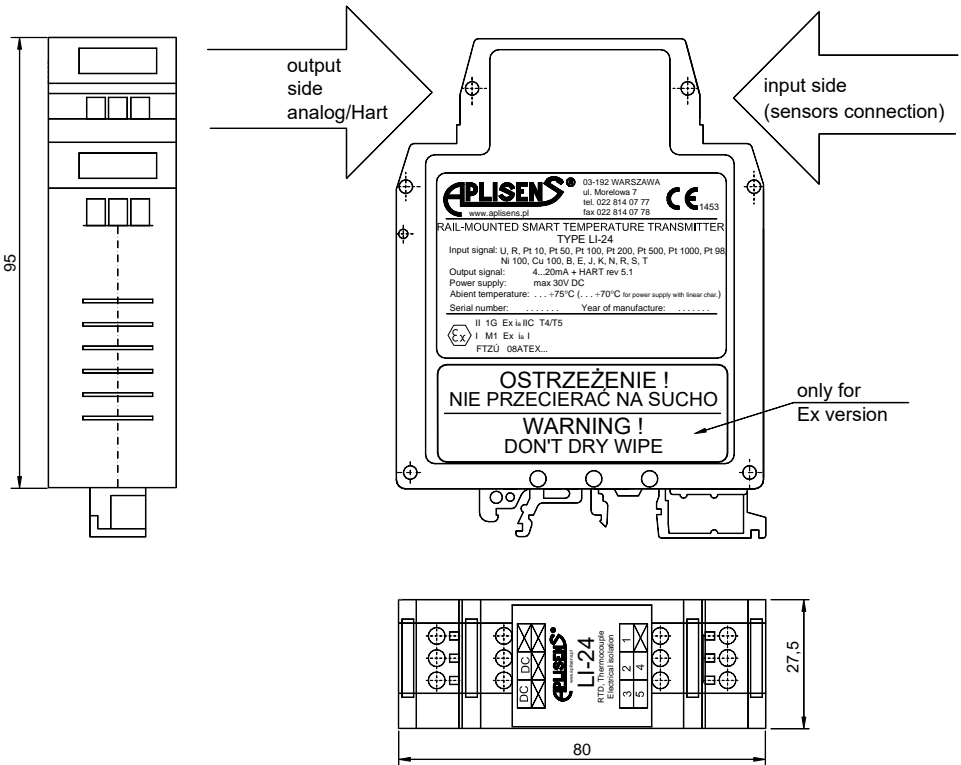

Fig.9. Smart temperature transmitter type LI-24, dimensions, description.

